



DESIGNED TO MOVE [YOU][®]

JWM72A

MOBILE AUDIO SYSTEM

Installation and Owner's Manual

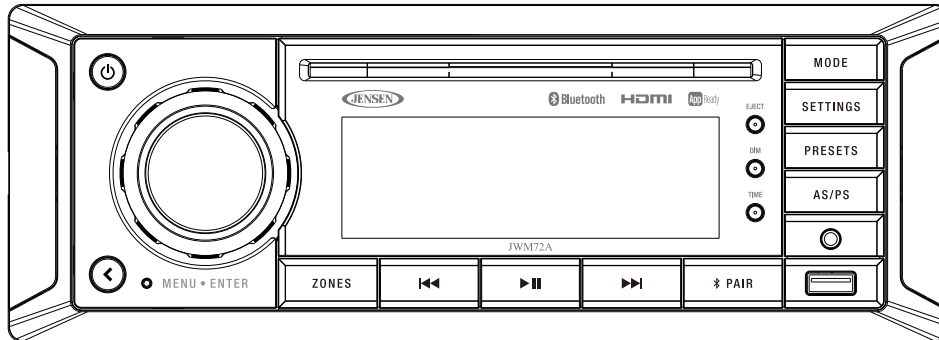



DESIGNED TO MOVE [YOU]™

Introduction.....	3
Disc Notes.....	4
Installation.....	5
Wiring.....	6
Basic Operation.....	7
Tuner Operation.....	10
Disc Operation.....	11
DVD/VCD Operation	12
MP3/USB Operation.....	14
Bluetooth Operation.....	16
App Operation.....	17
Remote Control Operation.....	18
DVD Setup Menu.....	20
Care and Maintenance.....	22
Troubleshooting.....	22
Specifications.....	23
FCC Notice.....	23

INTRODUCTION

Thank You!

Thank you for choosing a Jensen product. We hope you will find the instructions in this owner's manual clear and easy to follow. If you take a few minutes to look through it, you'll learn how to use all the features of your new Jensen receiver for maximum enjoyment.

Features

Features of Jensen JWM72A mobile audio system include:

- Digital AM/FM Tuner/30 Preset stations (12 AM/18 FM)
- Bluetooth Ready with A2DP/AVRCP Streaming Audio
- APP Ready
- Pre-set Equalizer -5 settings (User > Flat > Pop > Classical > Rock)
- Electronic Bass, Treble, Balance and Fader Controls
- DVD/CD-R/RW and MP3 Compatible
- HDMI Video Output with JCOM link
- HDMI ARC
- Time/Alarm Clock
- White LED Backlit LCD
- 1/8" Front Auxiliary Audio Input
- Rear Audio RCA Inputs/Outputs
- USB Playback of MP3/WMA Files
- 3 Zone / 8 Speaker Output
- Independent Zone Volume Control
- Wireless Remote Control Included

Precautions

- **Use the Proper Power Supply.**
This product is designed to operate with a 12 volt DC, negative ground battery system (the standard system in a North American vehicle).
- **Protect the Disc Mechanism.**
Avoid inserting any foreign objects into the slot of this player. Failure to observe this may cause malfunction due to the precise mechanism of this unit.
- **Use Authorized Service Centers.**
Do not attempt to disassemble or adjust this precision product; contact a professional for assistance.

- **Avoid Moisture.**
To reduce the risk of fire or electric shock, do not expose this equipment to rain or moisture.
- **Avoid Cleaning Products.**
The front of this unit should only be cleaned with a slightly damp cloth. Do not use cleansers.
- **Use Recommended Accessories.**
TO REDUCE THE RISK OF FIRE OR ELECTRIC SHOCK AND ANNOYING INTERFERENCE, USE ONLY THE RECOMMENDED ACCESSORIES.

CAUTION: This mobile DVD player is a Class I laser product that uses a visible/invisible laser beam which could cause hazardous radiation exposure if improperly directed. Be sure to operate the mobile DVD player as instructed. Use of controls or adjustments or performance of procedures other than those specified herein may result in hazardous radiation exposure. Do not open covers and do not attempt to repair the unit yourself. Refer servicing to qualified personnel.

Packing List

JWM72A

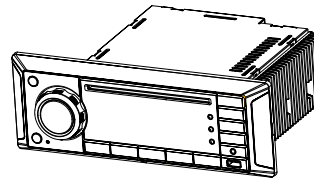

SCREW COVER

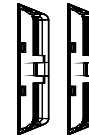

Remote Control

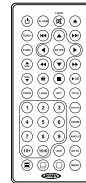

20-PIN Speaker Wire

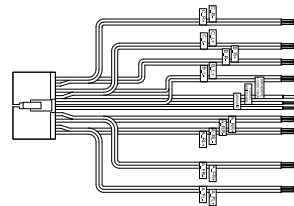

AUX AUDIO/VIDEO CABLE



DESIGNED TO MOVE [You][®]

DISC NOTES



Depending on the recording status, conditions of the disc, and the equipment used for recording, some CD-Rs/CD-RWs may not play on this unit. For more reliable playback, please adhere to the following recommendations:

- Use CD-RWs with speed 1x to 4x and write with speed 1x to 2x.
- Use CD-Rs with speed 1x to 8x and write with speed 1x to 2x.
- Do not play a CD-RW which has been written more than 5 times.

NOTE: CD-R and CD-RW discs will not play unless the recording session is closed and the CD is finalized.

Disc Maintenance

- A dirty or defective disc may cause sound dropouts while playing. Before playing, wipe the disc using a clean cloth, working from the center hole towards the outside edge. Never use benzene, thinners, cleaning fluids, anti-static liquids or any other solvent.
- Be sure to use only round CDs for this unit and do not use any special shape CDs. Use of special shape CDs may cause the unit to malfunction.
- Do not stick paper or tape on the disc. Do not use CDs with labels or stickers attached or that have sticky residue from removed stickers.
- Do not expose discs to direct sunlight or heat sources such as hot air-ducts, or leave them in a vehicle parked in direct sunlight where there can be a considerable rise in temperature inside the vehicle.

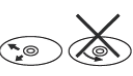
			
Insert label side up.	Do not bend.	Never touch the underside of the disc.	Wipe clean from this center to the edge.

NOTE: A disc may become scratched (although not enough to make it unusable) depending on how you handle it and other conditions in the usage environment. These scratches are not an indication of a problem with the player.

INSTALLATION

It's a good idea to read all of the instructions before beginning the installation. We recommend having your Jensen JWM72A installed by a reputable RV dealership.

Tools and Supplies

You will need these tools and supplies to install your JWM72A:

- Phillips screw driver
- Wire cutters and strippers
- Tools to remove existing radio (screwdriver, socket wrench set or other tools)
- Electrical tape
- Crimping tool
- Volt meter/test light
- Crimp connections
- 16 gauge wire for power connections
- 16 –18 gauge speaker wire
- Four M3x20mm (3/32 x 0.75") screws

Disconnecting the Battery

To prevent a short circuit, be sure to turn off the ignition and remove the negative (-) battery cable prior to installation.

NOTE: If the JWM72A is to be installed in a vehicle equipped with an on-board drive or navigation computer, do not disconnect the battery cable. If the cable is disconnected, the computer memory may be lost. Under these conditions, use extra caution during installation to avoid causing a short circuit.

Selecting the Mounting Location

Select a mounting location, taking care to avoid the following:

- Places exposed to heat-radiating appliances such as electric heaters
- Adjacent to other equipment that radiates heat
- Poorly-ventilated or dusty places
- Moist or humid locations

Mounting the Radio

- Use the mounting hole diagram to measure and cut a mounting hole
- Route power, speakers, AV, and antenna cables through the hole and connect
- Check and ensure correct operation
- Mount the unit using four M3x20mm (3/32 x 0.75") screws
- Attach the screw covers

NOTE: Before cutting the mounting hole, make sure the area behind the mounting location is clear of wires, fuel and vacuum or brake lines.

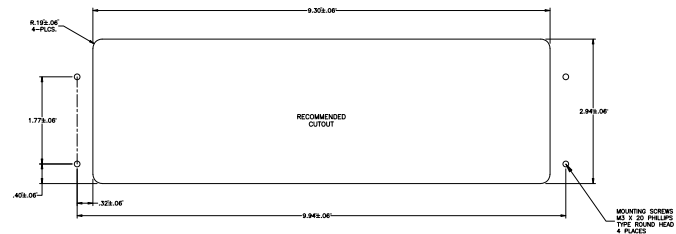

BASIC OPERATION

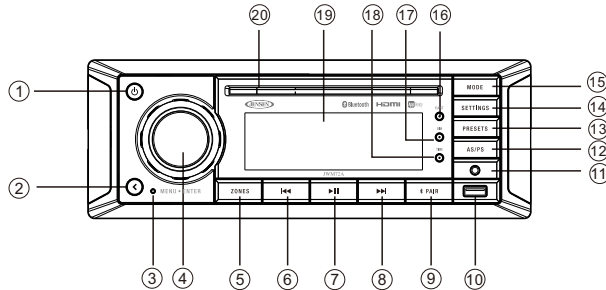

Power

Press the **POWER** button (1) to turn the unit on.
The unit will resume at the last mode (Tuner, Aux, etc.).

Zones Volume Control

1. Press the **ZONES** button (5) to enter the zone menu.
2. While in the zone menu, press **ZONES**, **ENTER** (4), or the **<<** or **>>** buttons (6, 8) to change the active zone (ZONE A, ZONE B and ZONE C) for volume adjustment control.
NOTE: Zone A also controls the output of the rear line level audio out.
3. Rotate the **VOL/ENTER** knob (4) clockwise to increase or counter-clockwise to decrease the active zone's volume.

NOTE: Set the zone volume to '0' to turn off the zone.
Each zone has a maximum volume setting of '40'. While adjusting the volume, the LCD displays numerical representation of the level.

Zone Mute

While in zone menu (see above), press and hold the **ENTER** knob button to mute the audio output of the active zone's volume. Press and hold again to restore the previous volume level.

Pause / Mute

During **RADIO / FRONT AUX / REAR AUX / HDMI ARC** mode, press the **▶||** button (7) to mute the audio output for all zones. Press again to restore the previous volume level.

During **USB / DVD / BT** mode, press the **▶||** button to pause playback. Press again to resume playback.

Mode

1. Press the **MODE** button (15), the LCD will display "MODE" and access mode selection.
2. Press the **MODE** button, **<<** or **>>** buttons (6, 8), or rotate the **VOL/ENTER** knob to cycle through the available modes and choose the desired mode. Available modes are AM, FM, FRONT AUX, REAR AUX, HDMI ARC, DISC and USB.
3. Press **ENTER** knob (4) to confirm the mode selection.

Audio Menu Setting

1. Press the **SETTINGS** button (14) to access the audio menu.
2. Press the **<<** or **>>** buttons (6, 8) or **SETTINGS** button repeatedly to navigate through the audio menu items.
3. Once the desired menu item appears on the display, adjust that option by rotating the **VOL/ENTER** knob (4) clockwise or counter-clockwise within 5 seconds.
4. Press the **Back** button (2) to confirm your selection and exit audio menu. The unit will automatically exit the audio menu after 5 seconds of inactivity.

The following items can be adjusted:

- **BASS**: Adjust the Bass level from "-7" to "+7".
- **TREBLE**: Adjust the treble from "-7" to "+7".
- **BALANCE**: Adjust the Balance between the left and right speakers output from "LEFT 7" (full left) to "RIGHT 7" (full right).
"BALANCE 0" indicates equal balance between the left and right speakers.
- **FADE**: Adjust the speaker fade between the rear and front speakers from "REAR 7" (full rear) to "FRONT 7" (full front).
"FADE 0" indicates equal balance between the rear and front speakers.
- **LOUDNESS**: Toggle the loudness on/off. When listening to music at low volumes, this feature will boost the bass/treble range to compensate for the characteristics of human hearing.
- **EQUALIZATION**: Choose one of the following pre-defined bass and treble curves: **POP > CLASSICAL > ROCK > FLAT**.

System Menu Setting

1. Press and hold the **SETTINGS** button (14) for 2 seconds to access the system menu.
2. Press the **<<** or **>>** buttons (6, 8) or **SETTINGS** button repeatedly to navigate through the system menu items.
3. Once the desired menu item appears on the display, adjust that option by rotating the **VOL/ENTER** knob clockwise or counter-clockwise within 5 seconds.
4. Press the **Back** button (2) to confirm your selection and exit audio menu. The unit will automatically exit the audio menu after 5 seconds of inactivity.

The following items can be adjusted:

- **BLUETOOTH DEVICE** (Lock/Unlock, Disconnect/Connect, Delete): View, lock and delete from a list of previously paired mobile phone device models.
- **BEEP (ON/OFF)**: Turn the audible beep On/Off (heard when functions/buttons are selected).

Note: Beep tone off will not affect the audible tone of the alarm clock.

- REGION (USA/EUROPE): Set frequency spacing for various regions.
- BLUETOOTH (ON/OFF): Choose "Bluetooth On" or Bluetooth Off".
- PRESET VOL (1-40): Select an automatic turn on volume.
- RESET <ENTER>: Press the ENTER button to return the JW7M2A to factory default settings.

Auxiliary Input Function

When a portable audio device is connected to the unit, press the **MODE** button (15) repeatedly until FRONT AUX / REAR AUX mode is selectable, then press **ENTER** (4) knob to enter the FRONT AUX / REAR AUX mode. To connect a portable audio device, insert a standard 3.5mm (audio line output or headphone output from your portable CD / MP3 or other media player) into the AUX connector (AUX FRONT) (11) on the front of the unit or the AUX-IN RCA jack (AUX REAR) on the left chassis of the unit.

Auxiliary Input Connector

For front panel audio input, an external audio source can be connected to the front panel audio input with a 3.5mm audio cable adapter. Connect the device to the AUX connector (11) on the front panel.

In addition to front panel auxiliary input source, the unit can also be connected to the RCA audio input through the AUX-IN RCA jack on the left chassis of the unit.

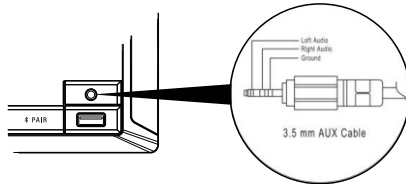

USB Interface Connector

You can connect a USB device directly to USB interface (10) on the front of the JW7M2A for playback of compatible files. Press the **MODE** button repeatedly until USB mode is selectable. Refer to "MP3/USB Operation" on page 13 for additional operating instructions.

NOTE: USB will not support Apple device playback. The USB input supplies up to 1A of charging current.

Liquid Crystal Display (LCD)

The current activated functions and time are shown on the LCD panel (19).

Dimming control

1. Press the **DIM** button (17) on the front panel to turn the dimmer On (selected brightness level) and press again to turn the dimmer Off (maximum brightness level).

2. Press & Hold the **DIM** button (17) to access DIMMER LEVEL menu.
3. Rotate the volume knob clockwise to increase or counter-clockwise to decrease the brightness of button and LCD backlight from "BRIGHTNESS 0" to "BRIGHTNESS 8". "BRIGHTNESS 0" indicates the LCD backlight is turned off.
4. Press the **BACK** button (2) to confirm your selection and exit menu.

NOTE: LCD panels may take longer to respond when subjected to cold temperatures for an extended period of time. In addition, the visibility of the numbers on the LCD may decrease slightly. The LCD display will return to normal when the temperature increases to a moderate range.

Time Menu Settings

1. Press the **TIME** button (18) to access time menu settings.
2. Press the << or >>| buttons (6, 8) or **TIME** button repeatedly to navigate the time menu.
3. Once the desired time menu item appears on the display, adjust that option by rotating the **VOL/ENTER** knob clockwise or counter-clockwise within 5 seconds.

The following items can be adjusted:

- SLEEP TIMER: select the sleep time from 0 (OFF), 15, 30, 45 or 60 minutes. The sleep timer will automatically turn off the JW7M2A in designated number of minutes.
- ALARM (ON/OFF): to turn the alarm function on or off.
- ALARM SET: The hour clock digit will flash, Rotate the **VOL/ENTER** knob clockwise or counter-clockwise to adjust the hour. Press the **ENTER** knob to access the minute adjustment. Press the **ENTER** knob again to save the alarm time and return to ALARM ON/OFF setting.
- CLOCK SET: The hour clock digit will flash, Rotate the **VOL/ENTER** knob clockwise or counter-clockwise to adjust the hour. Press the **ENTER** knob to access the minute adjustment. Press the **ENTER** knob again to save the clock time.

Press the **BACK** button (2) to confirm your selection and exit time menu. The unit will automatically exit the audio menu after 5 seconds of inactivity.

Remote Sensor

Infrared receiver is located on the front panel to receive infrared signal emitted by the remote control.

Reset

The reset button should be activated for the following reasons:

- Initial installation of the unit when all wiring is completed
- Function buttons do not operate
- Error symbol on the display

HDMI ARC

Use a ball point pen or thin metal object to press the **RESET** button (3). Connect HDMI cable to JENSEN TV with ARC function and JW7M2A radio head unit. If the set up and operation is correct, the TV audio will come out from the speaker of the head unit after switching to HDMI ARC mode.



DESIGNED TO MOVE [You][®]

See the ARC function Operation in the following table:

No	Device Status		User Operation	Operation Results		Remarks
	Head Unit	TV		Head Unit	TV	
1	Power ON (HDMI ARC)	Power ON	Power OFF TV	Power OFF	Power OFF	
2	Power OFF	Power OFF	Power ON TV	Power OFF	Power ON	
3	Power OFF (Last mode is HDMI ARC before Power OFF)	Power OFF	Power ON Head Unit	Power ON (HDMI ARC)	Power ON (Last mode before power off)	
4	Power OFF (Last mode is HDMI ARC before Power OFF)	TV, AV, USB, HDMI (non-HDMI ARC)	Power ON Head Unit	Audio Out	No Audio Out	If the TV can play the device automatically, there will be TV audio out. Otherwise, switch to USB mode to play the device.
5	Power ON (HDMI ARC)	TV, AV, USB, HDMI (non-HDMI ARC)	Power OFF Head Unit	No Audio Out	Audio Out	
6	DISC Mode	DISC disc content	Switch TV to another (such as TV, AV, USB, non-HDMI ARC mode)	Switch to HDMI ARC Mode and Audio out from Head unit in HDMI ARC mode	No Audio Out	
7	HDMI ARC Mode	TV, AV, USB, HDMI (non-HDMI ARC)	Switch Head unit to another mode (Such as FM, Bluetooth, DVD or AUX)	No Audio out (No HDMI ARC Audio Out)	Audio Out	TV Speaker ON
8	HDMI ARC Mode	TV, AV, USB, HDMI (non-HDMI ARC)	TV Audio Receiver OFF	No Audio Out	Audio Out	TV Speaker ON
			TV Audio Receiver ON	Audio Out	No Audio Out	TV Speaker ON
9	HDMI ARC Mode	TV, AV, USB, HDMI (non-HDMI ARC)	TV CEC Mode OFF	No Audio Out	Audio Out	TV Speaker ON
			TV CEC Mode ON Audio Receiver ON	Audio Out	No Audio Out	TV Speaker ON

TUNER OPERATION

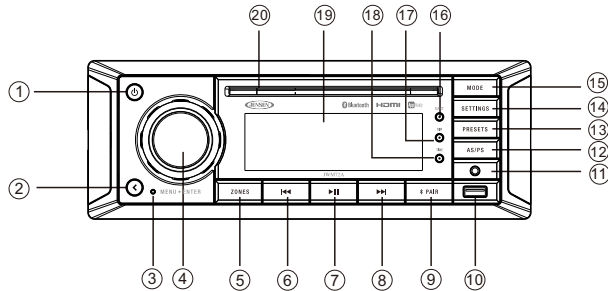

Select a Band

1. Press **MODE** button (15), the LCD will display "MODE" at top line of the screen and enter mode selection.
2. Press **MODE** button (15) repeatedly or **|<< or >>|** buttons (6, 8) or rotating the **VOL/ENTER** knob to navigate the available modes and choose AM or FM mode.
3. Press **ENTER** knob button (4) to confirm the selection.

Manual Tuning

Press the **>>|** or **|<<<** buttons (8, 6) to seek stations up/down step by step.

Auto Seek Tuning

Press and Hold the **>>|** or **|<<<** buttons (8, 6) to automatically seek the next or previous strong station.

Presets station menu

Store a station

1. Press the **PRESETS** button (13) to access the preset menu.
2. Press **|<< or >>|** buttons (6, 8) or rotate the **VOL/ENTER** knob to select the preset location to store.
3. Press and Hold the **ENTER** knob to store the current station at that preset location.

4. Press the **BACK** button (2) to exit presets menu.

Recall preset stations

1. Press the **PRESETS** button (13) to access the preset menu.
2. Press **|<< or >>|** buttons (6, 8) or rotate the **VOL/ENTER** knob to navigate the 6 preset stations.
3. Press the **ENTER** knob to confirm the selection
4. Press the **BACK** button (2) to exit preset menu.

The LCD will display the current station on 1st line and the preset station selection on the 2nd line in presets menu.

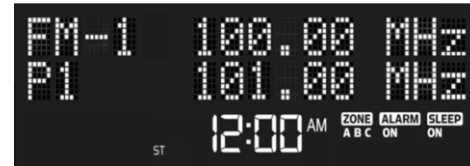

Automatically Store / Preset Scan (AS/PS)

Automatically Store

Select a band. Press and Hold the **AS/PS** button (12) for more than 3 seconds and the unit will automatically scan for and store 12 or 18 strongest stations for AM or FM respectively. To stop this function before the automatic storing is complete, press **AS/PS** again.

Preset Scan

Select a band. Press **AS/PS** button to scan stations stored in the current band. The unit will pause for 10 seconds at each preset station. Press **AS/PS** again to stop scanning when the desired station is reached.

DISC OPERATION

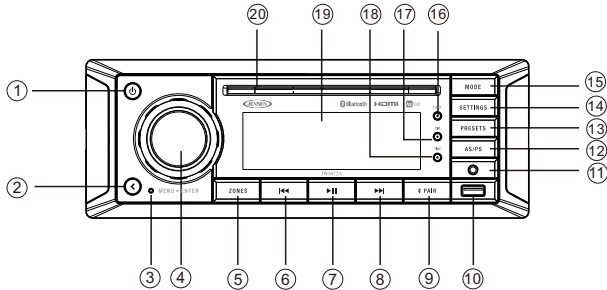

CD OPERATION

Inserting a CD

Inserting a CD label-side up into the disc slot (20) and the disc will begin to play automatically.

Ejecting a CD

Press the **EJECT** button (16) to stop CD play and eject the CD.

Pausing Playback

Press the **▶||** button (7) to suspend or resume disc play.

Stop Playback

Press & hold the **▶||** button (7) to suspend disc play, and "PRE STOP" will appear in the display.

Press the **▶||** button to resume disc play from the last position. Press & hold the **▶||** button (7) again and "STOP" will appear on the display.

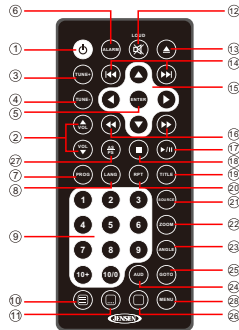

Track Select

Press the **>>|** or **|<<** button (8, 6) to advance to the previous or next track on the CD. The selected track number will appear on the display. Press and hold the **>>|** or **|<<** button for more than three seconds to fast forward or fast reverse through the disc. CD plays start when the play/pause button is pressed.

Fast Forward/Reverse

Press and hold the **>>|** or **|<<** button (8, 6) or press the **>>** or **<<** buttons on the remote control (16) once for FAST FORWARD/REVERSE. Press and hold again for FAST FORWARD/REVERSE X 4, X 8, X 20 or PLAY. Press the **▶||** button (7) on the control panel or remote control (17) to end fast forward or reverse and resume normal playback.

Playback menu setting (Intro Scan/Repeat/Random)

1. Press the **ENTER** knob (4) to access the playback menu settings (Intro Scan/Repeat/Random).
2. Press the **|<<** or **>>|** buttons (6, 8) repeatedly to navigate the playback menu.
3. Once the desired playback menu item appears on the display, adjust that option by rotating the **VOL/ENTER** knob clockwise or counter-clockwise within 5 seconds.
4. Press the **ENTER** knob (4) to confirm selection.
5. Press the **BACK** button (2) to confirm your selection and exit time menu. The unit will automatically exit the playback menu after 5 seconds of inactivity.

The following playback menu items can be adjusted:

- **INTRO SCAN:** To play the first 10 seconds of each track on the current disc. Press **ENTER** knob to turn the intro scan function on or off.
- **REPEAT:** Rotating the volume knob to select REPEAT ONE to continuously repeat the selected track (RPT ONE), REPEAT ALL to repeat all tracks, REPEAT OFF to stop the repeat function.
- Press the **RPT** buttons on the remote control (20) to access repeat function.
- **RANDOM SHUFFLE:** To play all tracks on a CD in random, shuffle order. Rotating the **VOL/ENTER** knob clockwise or counter-clockwise to turn the random function on or off.

Programmed Playback

1. Press the **PROG** button (7) on the remote control to access the programmed playback screen.



- Use the ◀▶ or ▲▼ cursor buttons (15) on the remote control to access the fields on the “PROG” screen.
- Use the number buttons on the remote control to enter a track number in each field.
- Press the ▶/|| button (17) on the remote control or highlight “PLAY” on screen and then press the ENTER button (5) to begin playback in the numbered order indicated to delete the list, highlight “CLEAR” and then press ENTER. Press PROG to exit the programmed playback screen.

Remote Control Direct Track Entry

To select a track directly, use the number pad on the remote control (10). For single digit entries, press the corresponding number for two digit entries. Press the **10+** button followed by the last digit (i.e., for track 16, press **10+** and then 6).

GOTO Direct Track/Chapter Access

Use the GOTO function to access a track (chapter) directly.

- Press the **GOTO** button (25) on the remote control. The On Screen Display information will appear with the track number highlighted.
- Use the number keys on the remote control to enter the 3-digit track number directly (i.e. for track 10, enter “010”)
- Press the ENTER button (5) to confirm and begin playback.

CD Playback Information

The following information is displayed at the top of the screen during CD playback:



TRK ###/### – “1/18” indicates the first of 18 tracks on the CD is currently playing.

CX “X” indicates repeat play is OFF, “1” indicates repeat track, and “A” indicates repeat disc.

Press the **□** button on the remote control (26) repeatedly to view the following information for elapsed/remaining playing time:

⌚ 00:02:18 –total elapsed playing time of current track;

C –00 :34 :37 –remaining playing time of current track;

T 00:02:18 –total elapsed playing time for current disc;

T–00 :34 :37 –remaining playing time for current disc.

DVD/VCD OPERATION

Inserting a Disc

Insert a disc label-side up into the disc slot (15) and the disc will begin to play.

Ejecting a DVD

Press the **EJECT** button (16) to stop DVD play and eject the DVD.

Play/ Pausing Playback

Press the ▶|| button (7) to suspend or resume disc play.

Stop Playback

Press & hold the ▶|| button (7) to suspend disc play, and “PRE STOP” will appear in the display. Press the ▶|| button to resume disc play from the last position. Press & hold the ▶|| button (7) again and “STOP” will appear on the display.

Track Select

Press the >>| or |<<< button (8, 6) to advance to the previous or next track on the disc. The selected track number will appear on the display. Press and hold the >>| or |<<< button for more than three seconds to fast forward or fast reverse through the disc. Disc plays start when the play/pause button is pressed.

Fast Forward/Reverse

Press and hold the >>| or |<<< button (8, 6) or press the >> or << buttons on the remote control (14) once for FAST FORWARD/REVERSE X 2. Press and hold again for FAST FORWARD/REVERSE X 4, X 8, X 20 or PLAY. Press the ▶|| button (7) on the control panel or remote control (17) to end fast forward or reverse and resume normal playback.

Playback menu setting (Disc Menu/Repeat)

- Press the **ENTER** knob (4) to access the playback menu settings (DISC MENU/REPEAT).
- Press the |<<< or >>| buttons (6, 8) repeatedly to navigate the playback menu.
- Once the desired playback menu item appears on the display, adjust that option by rotating the **VOL/ENTER** knob clockwise or counter-clockwise within 5 seconds.
- Press the **ENTER** knob (4) to confirm selection.
- Press the **BACK** button (2) to confirm your selection and exit time menu. The unit will automatically exit the playback menu after 5 seconds of inactivity.

The following playback menu items can be adjusted:

- DISC MENU: Press **ENTER** knob to access disc menu option.
- REPEAT (VCD): Rotating the **VOL/ENTER** knob clockwise or counter-clockwise to select from the following repeat play options:
 VCD: REPEAT TRACK, REPEAT ALL (disc), REPEAT OFF
 DVD: REPEAT CHAPTER, REPEAT TITLE, REPEAT All, REPEAT OFF
 REPEAT CHAPTER to repeat disc chapter
 REPEAT TITLE to repeat disc title
 REPEAT TRACK to continuously repeat the selected track
 REPEAT ALL to repeat all tracks
 REPEAT OFF to stop the repeat function.
 Press the **RPT** buttons (20) on the remote control to access repeat function.

DESIGNED TO MOVE [You]™

Programmed Playback

1. Press the **PROG** button (7) on the remote control to access the programmed playback screen.



2. Use the **◀▶** or **▲▼** cursor buttons (15) on the remote control to access the fields on the "PROG" screen.
3. Use the number buttons on the remote control to enter a track number in each field.
4. Press the **▶||** button (17) on the remote control or highlight "PLAY" on screen and then press the **ENTER** button (5) to begin playback in the numbered order indicated to delete the list, highlight "CLEAR" and then press **ENTER**. Press **PROG** to exit the programmed playback screen.

DVD Playback Features

The following remote control features, along with many others, are available during DVD playback (see "Remote Control Operation" on page 17 for complete functionality):

- **LANG:** Press to choose an alternate audio language, if available.
- **SUBTITLE:** Press to select an alternate subtitle language, if available.
- **ANGLE:** Press to select an alternate viewing angle, if available.
- **ZOOM:** Press to zoom the picture at ZOOM 2, ZOOM 3, ZOOM 4,
- **ZOOM 1/2, ZOOM 1/3 or ZOOM 1/4,** or select OFF to return to normal view.

NOTE: Feature availability is dependent upon DVD embedded information.

Playback Information

During DVD playback, press the **□** button (26) on the remote control to display playback information on the screen, including the media playing and current playback time. Press the **□** button(26) additional times to display additional information, as indicated below.

DVD Playback Information

The following information is displayed at the top of the screen during DVD playback:

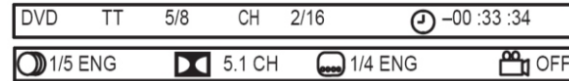

TT 5/8 – "5 / 8" indicates the fifth of 8 titles on the DVD is currently playing.
 CH 2/16 – "2 / 16" indicates that the second of 16 chapters on the DVD is currently playing.

Press **□** repeatedly to view the following information: for elapsed/remaining playing time:

00:02:18 –total elapsed playing time of the current track;

C –00:34:37 –remaining playing time of the current track;

T 00:02:18 –total elapsed playing time for disc;

T –00:34:37 –remaining playing time for disc.

- **1/5 ENG** –English is the selected audio language out of 5 possible choices;
- **5.1 CH** –The current language is recorded in 5.1 surround sound;
- **1/4 ENG** –English is the selected subtitle language out of 4 possible choices;
- **OFF** –There are no alternate angles recorded for this scene.

Remote Control Direct Track Entry

To select a track directly, use the number pad on the remote control (10). For single digit entries, press the corresponding number. For two digit entries, press the **10+** button followed by the last digit (i.e., for track 16, press **10+** and then **6**).

GOTO Direct Track/Chapter Access

Use the **GOTO** function to access a track (chapter) directly.

1. Press the **GOTO** button (25) on the remote control. The On Screen Display information will appear with the track number highlighted.
2. Use the number keys on the remote control to enter the 3-digit track number directly (i.e. for track 10, enter "010").
3. Press the **ENTER** button to confirm and begin playback.

MP3/USB OPERATION

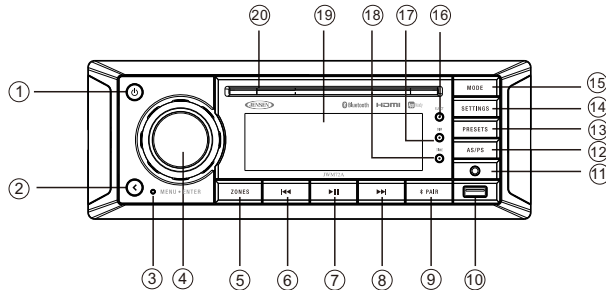

If the user connects a USB mass storage device, the radio automatically power on, if necessary, and switches to digital file playback mode and selects that physical media. Changing modes or turning off the radio pauses playback. Playback will resume exactly where paused when returning to digital file playback mode.

Inserting a USB Device

The **USB** connector (10) is at the bottom right corner of the panel. Press the **Mode** button (15) repeatedly and choose the USB mode to enter USB playback mode. The LCD will display "LOADING" and "USB" while files are initially loaded.

When USB is removed, it will automatically back to the previous mode before the USB is connected.

NOTE: MP4 video format is not supported.

Notes on MP3 Playback
 Any directory that does not include a MP3 file is skipped.
 Maximum number of folders: 512 (including skipped directories).
 Maximum number of folder levels: 12

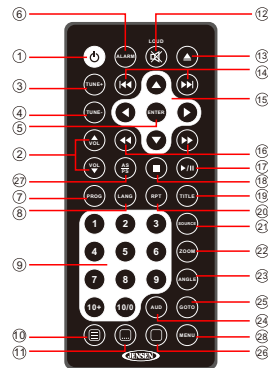

Maximum number of MP3 files: 999
 Maximum number of characters for MP3 file name and folder name: 32
 Maximum number of Characters of ID3 Tag:
 ID3 Tag version 1.0: 32
 ID3 Tag version 2.x: 32

MP3 Monitor Display

After loading an MP3 disc or USB device, the following screen will appear on your output Monitor.

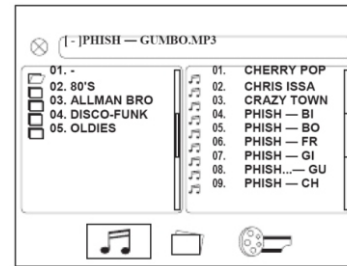

Select one of these icons to access the corresponding media on your disc or USB device. If the media type is not present, the icon will not be selectable.



Audio



Photos



Video

Play/Pause

Press the **▶||** button (7) to suspend or resume media playback.

Track Select

Press the **||<<** or **>>||** buttons (6, 8) or **||<<** or **>>||** button (14) on the remote control to advance to the next or previous track in the current folder. The selected track number will appear on the display.

Playback menu setting (Intro Scan/Repeat/Random/Folder)

1. Press the **ENTER** knob (4) to access the playback menu settings (Intro Scan/Repeat/Random/Folder).
2. Press the **||<<** or **>>||** buttons (6, 8) repeatedly to navigate the playback menu.
3. Once the desired playback menu item appears on the display, adjust that option by rotating the **VOL/ENTER** knob clockwise or counter-clockwise within 5 seconds.

4. Press the **ENTER** knob (4) to confirm selection.
5. Press the **BACK** button (2) to confirm your selection and exit time menu. The unit will automatically exit the playback menu after 5 seconds of inactivity.

The following playback menu items can be adjusted:

- **INTRO SCAN:** To play the first 10 seconds of each track on the current disc. Press **ENTER** knob to turn the intro scan function on or off.
- **REPEAT:** Rotating the **VOL/ENTER** knob to select from the following repeat play options: **REPEAT TRACK** to continuously repeat the selected track (RPT 1)
- **REPEAT DIR** (folder) to repeat all tracks in a folder.
- **REPEAT ALL** (disc) to repeat all tracks.
- **REPEAT OFF** to stop the repeat function.
- Press the **RPT** buttons (20) on the remote control to access repeat function.
- **RANDOM SHUFFLE:** To play all tracks on a CD in random, shuffle order. Rotating the **VOL/ENTER** knob clockwise or counter-clockwise to turn the random function on or off.
- **FOLDER:** Rotating the **VOL/ENTER** knob clockwise or counter-clockwise to access a higher or lower folder level.

Programmed Playback

1. Press the **PROG** button (7) on the remote control to access the programmed playback screen.
2. Use the **◀▶** or **▲▼** cursor buttons (15) on the remote control to access the fields on the "PROG" screen.
3. Use the number buttons on the remote control to enter a track number in each field.
4. Press the **▶/||** button (17) on the remote control or highlight "PLAY" on screen and then press the **ENTER** button (5) to begin playback in the numbered order indicated to delete the list, highlight "CLEAR" and then press **ENTER**. Press **PROG** to exit the programmed playback screen."



Remote Control Direct Track Entry

To select a file directly, use the number pad on the remote control (9). For single digit entries, press the corresponding number. For two digit entries, press the **10+** button followed by the last digit (i.e., for file 16, press **10+** and then **6**).

GOTO Direct Track/Chapter Access

Use the **GOTO** function to access a track (chapter) directly.

1. Press the **GOTO** button (25) on the remote control. The On Screen Display information will appear with the file number highlighted.
2. Use the number keys on the remote control to enter the 3-digit track number directly (i.e. for file 10, enter "010").
3. Press the **ENTER** button to confirm and begin playback.

MP3 Playback Information

The following information is displayed at the top of the screen during CD playback: **TRK ###/###** – "9/150" indicates the ninth of 150 tracks on the disc is currently playing. **OX** – "X" indicates repeat play is OFF, "1" indicates repeat song, and "D" indicates repeat directory (folder).

Press **□** repeatedly to view the following information for elapsed/remaining playing time:

⌚ 00:02:18 – total elapsed playing time for disc

C–00 :34 :37 – remaining playing time

T 00:02:18 – total elapsed playing time for current track

C –00 :34 :37 – remaining playing time for current track



DESIGNED TO MOVE [You][™]

BLUETOOTH OPERATION

The JWM72A includes built-in Bluetooth technology that allows you to connect this head unit to Bluetooth devices for streaming audio playback.

About Bluetooth Technology

Bluetooth wireless technology is a short-range wireless radio protocol. Operating in the 2.4 GHz range, it transmits audio and data at speeds up to 2.1 Mbit/s over a range of up to 10 meters.

Bluetooth On/Off

Bluetooth mode is turned ON by default. Bluetooth can be turned OFF to reduce the standby current draw of the JWM72A. Press and hold the **SETTINGS** button (14) to enter menu adjustment mode. Repeatedly press the **>>|** or **|<<** buttons (8, 6) or **SETTINGS** button to access BLUETOOTH ON/OFF. Rotate the **VOL/ENTER** knob to select **ON** or **OFF**.

Bluetooth Menu Options

NOTE: Please note that some Bluetooth menu options are only available while the unit is in Bluetooth Audio mode.

Press and Hold the **SETTINGS** button (14) to enter menu adjustment mode. The following additional menu options are available when the unit is in Bluetooth mode.

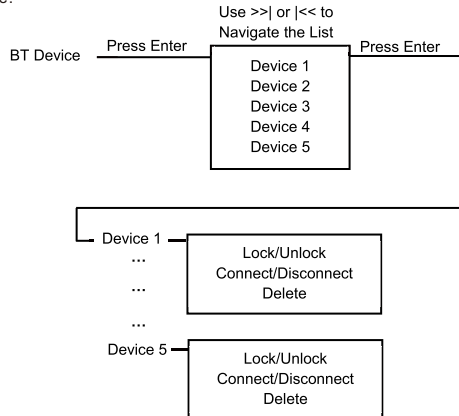

- **BLUETOOTH PAIR:** Press the **ENTER** knob to make the JWM72A available to pair with a Bluetooth enabled device.
- **BLUETOOTH DEVICES:** Press the **ENTER** knob button to view a list of previously paired mobile devices models. Press the **>>|** or **|<<** buttons to view devices from the list. You cannot delete a device that is actively connected. Press the **ENTER** knob button to select the device. Press the **>>|** or **|<<** buttons to choose Locked/Unlocked, Connect/Disconnect or Delete for this device.
- **CONNECT/DISCONNECT:** To disconnect a paired device, press the **ENTER** knob button to temporarily remove the BT link. The link can be re-established through your phone menu by selecting the JWM72A for connection.
- **LOCKED/UNLOCKED:** The JWM72A can store up to 5 devices for BT connection. The devices are stored in FIFO (First In First Out) order. To prevent a device from being bumped from the list when more than 5 devices are used, you must lock the device. To Lock/Unlock a device, press the **ENTER** knob button.
- **DELETE:** To delete a device from the list, Press the **ENTER** knob button.

Pairing a Bluetooth Device

Before you begin, consult the owner's manual for the Bluetooth device you want to pair with the JWM72A.

Make sure the device you intend to pair with is on and ready to pair.

1. Press **PAIR** button (9) to enter Bluetooth mode.
 2. Press & Hold **PAIR** button to start Bluetooth pairing process.
- The JWM72A will display "PAIRING" and will be available to pair for 120 seconds.
3. In your device Bluetooth settings, select "JWM72A" to connect.

Answering a Call

When answering a call using the connected phone, BT AUDIO will pause. After hanging up from the call, BT AUDIO will automatically resume on some phones. It may be necessary to press the play button to resume BT AUDIO.

Bluetooth Audio (A2DP)

The A2DP music is available for Bluetooth enabled phones when the phone is connected. To access Bluetooth mode and play songs stored in your phone, press the **PAIR** button (9) to enter the Bluetooth mode.

Selecting Tracks

During playback, press the **>>|** or **|<<** button (8, 6) to play the previous or next track.



DESIGNED TO MOVE [YOU]™

JWM72A

Pausing Playback

During playback, press the ►|| button (7) to pause the Bluetooth audio playback. "BT PAUSE" will appear on the LCD. Press ►|| button again to resume playback.

If you change to another mode, the mobile device audio will pause. Press the ✕ PAIR button (9) to return to Bluetooth mode and resume mobile phone audio playback.

NOTE: *If a Bluetooth device is disconnected due to the power being turned off or if the device is disconnected inadvertently, the unit will automatically search for the matching BT mobile phone when the power is restored.*

APP OPERATION

JENSEN® Specialty Controller is the ultimate wireless remote control for your JENSEN stereo system. Store away your old remote and enjoy the convenience of all the primary functions of your JENSEN stereo right from your phone or tablet by transforming your mobile device into a functional stereo remote control!

Features

This app controls all of the primary functions of your stereo features including:

- Power on/off
- Volume and mute
- CD/DVD player
- AM/FM radio tuner: access station, recall, store presets, switch songs
- Bluetooth® streaming audio
- File structure visibility, track selection, track audible scan up and down via USB
- Auxiliary audio input control –analog AUX1 and AUX2.
- Zone volume selection A, B and/or C
- Audio menu controls-bass, treble, balance, fader, equalizer, volume and zone selection settings
- HDMI ARC
- Clock with sleep time and alarm on/off.
- Visual display feedback so you can see artist title and album on your mobile screen

Connecting and using jControl app

jControl is available on the App Store for Apple devices and the Google Play Store for Android devices. Search "jControl" to find and install the app on your smart device. After downloading and installing jControl app on your apple device, pair your device to the JWM72A as stated above for Bluetooth pairing.

When jControl is installed on Android operating system, close the app before Bluetooth pairing, otherwise there may be errors on Bluetooth connection.

REMOTE CONTROL OPERATION

REF	DESCRIPTION	TUNER	BLUETOOTH	CD/MP3/USB	DVD
1	Power	Turn radio on/standby mode.	Turn radio on/standby mode.	Turn radio on/standby mode.	Turn radio on/standby mode.
2	VOL +/-	Adjust volume up/down. Press for Audio Control Setup menu.	Adjust volume up/down. Press for Audio Control Setup menu.	Adjust volume up/down. Press for Audio Control Setup menu.	Adjust volume up/down. Press for Audio Control Setup menu.
3	TUNE +	Tune to higher station			
4	TUNE -	Tune to lower station			
5	ENTER			Confirm menu selection	Confirm menu selection
6	ALARM	Turn the alarm feature on/off.	Turn the alarm feature on/off.	Turn the alarm feature on/off.	Turn the alarm feature on/off.
7	PROG			Display Program Play Menu	Display Program Play Menu
8	LANG			Display MONO/L, MONO/R or STEREO.	Select alternate audio language, if available.
9	Numeric Keyboard	Use 1-6 to access preset stations.		Enter track number to access track directly. For track Number > 10, use 10+ followed by second digit.	Enter track number to access track directly. For track Number > 10, use 10+ followed by second digit.
10	Setup			View SETUP menu.	View SETUP menu.
11	Subtitle				Choose subtitle language, if available.
12	Mute/LOUD	Silence Audio output. Press and hold to turn LOUDNESS feature on/off.	Silence Audio output. Press and hold to turn LOUDNESS feature on/off.	Silence Audio output. Press and hold to turn LOUDNESS feature on/off.	Silence Audio output. Press and hold to turn LOUDNESS feature on/off.
13	Eject	Eject Disc.	Eject Disc.	Eject Disc.	Eject Disc.
14	Previous/Next		Select next/previous track.	Select next/previous track.	Select next/previous track.
15	Directional Buttons			Move to desired menu item and then press ENTER to confirm.	Use with DVD menu to move to desired menu item and then press ENTER to confirm
16	Fast Reverse/ Forward			Fast Forward 2X, 4X, 8X, 20X. Fast Reverse 2X, 4X, 8X, 20X.	Fast Forward 2X, 4X, 8X, 20X. Fast Reverse 2X, 4X, 8X, 20X.
17	Play/Pause Stop		Pause/resume playback	Pause/resume playback	Pause/resume playback
18	Stop			Stop playback.	Stop playback.

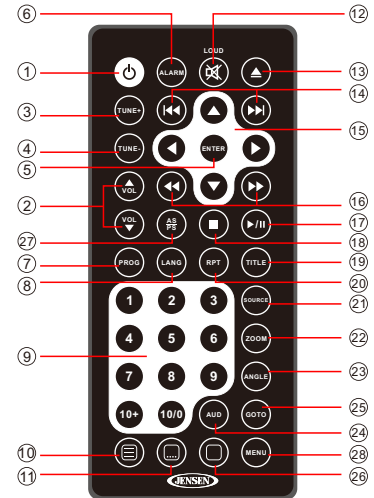

DESIGNED TO MOVE [You][®]

19	TITLE				Press to view title menu. Use directional arrows and play button to play selected title. May not be supported by all discs.
20	RPT			Repeat track	Repeat chapter
21	SOURCE	Select source for playback	Select source for playback	Select source for playback	Select source for playback
22	ZOOM				Zoom picture or press repeatedly to change magnification level.
23	ANGLE				Select alternate viewing angle, if available.
24	AUD	Access Audio Menu options.	Access Audio Menu options.	Access Audio Menu options.	Access Audio Menu options.
25	GOTO			Select exact time, track or chapter for playback.	Select exact time, track or chapter for playback.
26	Display			Display current playback information on the screen.	Display current playback information on the screen.
27	AS/PS	Browse preset stations (10 sec. interval). Press and hold to scan/store stations.			
28	MENU	Access system MENU.	Access system MENU.	Access system MENU.	Press to access system MENU. Press and hold to access DVD MENU.

DVD SETUP MENU

Press the (setup) button (10) on the remote control to access the SETUP menu and adjust system settings for the following categories:

- System Setup
- Language Setup
- Audio Setup
- Video Setup
- Digital Setup

While in the setup menu, use your directional arrows to select and change settings. The "up" and "down" arrows highlight the options, and the "right" and "left" arrows will change the setting for the highlighted option.

System Setup

The System Setup menu controls the following features:

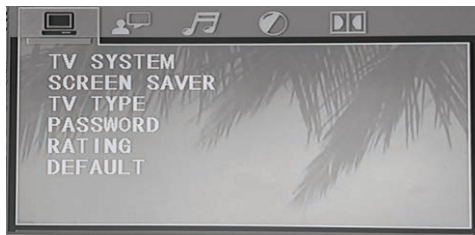

- **TV System:** This item is used to select a TV signal system to match your TV set. Select one of the following options: AUTO, NTSC or PAL.
- **Screen Saver:** Turn Screen Saver feature On/Off.
- **TV Type:** Select one of the following picture formats: 4:3PS, 4:3 LB or 16:9. 4:3 is a letterbox selection, and 16:9 is wide screen.
- **Password:** This item allows the selection of a new four-digit code to use for security purposes.
- **Rating:** Select the parental control level for all DVD play. The security password is required to make changes to this feature.
- **Default:** Use this item to restore default settings at any time.

Language Setup

The Language Setup menu controls the following features:



- **On-Screen Display (OSD) Language:** Set the OSD language to one of the following: English, German, Spanish, French.
- **Audio Language:** Set the audio language to one of the following: English, Japanese, French, Spanish, Portuguese, Latin or German.
- **Subtitle Language:** Set the subtitle language to one of the following: English, French, Spanish, Portuguese, German or OFF.
- **Menu Language:** Set the menu language to one of the following: English, French, Spanish, Portuguese, German.

Audio Setup

The Audio Setup menu controls the following features:



- **Audio Out:** This item defines the digital output format.
- **Key:** This item changes the audio output key.

Video Setup

The Video Setup menu controls the following features:



- Brightness
- Contrast
- Hue
- Saturation
- Sharpness

Digital Setup

The Speaker Setup menu controls the following features:



- OP Mode: Select LINE OUT or RF REMOD.
- Dynamic Range: Select FULL, 6/8, 4/8, 2/8 or OFF.
- Dual Mono: Select STEREO, MONO/L, MONO/R or MIX MONO.



DESIGNED TO MOVE [YOU]™

CARE AND MAINTENANCE

- Keep the product dry. If it does get wet, wipe it dry immediately. Liquids might contain minerals that can corrode the electronic circuits.
- Keep the product away from dust and dirt, which can cause premature wear of parts.
- Handle the product gently and carefully. Dropping it can damage circuit boards and cases, and can cause the product to work improperly.
- Wipe the product with a dampened cloth occasionally to keep it looking new. Do not use harsh chemicals, cleaning solvents, or strong detergents to clean the product.
- Use and store the product only in normal temperature environments. High temperature can shorten the life of electronic devices, damage batteries, and distort or melt plastic parts.

Ignition

The most common source of noise in reception is the ignition system. This is a result of the radio being placed close to the ignition system (engine). This type of noise can be easily detected because it will vary in intensity of pitch with the speed of the engine.

Usually, the ignition noise can be suppressed considerably by using a radio suppression type high voltage ignition wire and suppressor resistor in the ignition system. (Most vessels employ this wire and resistor but it may be necessary to check them for correct operation.) Another method of suppression is the use of additional noise suppressors. These can be obtained from most CB/A radio or electronic supply shops.

Interference

Radio reception in a moving environment is very different from reception in a stationary environment (home). It is very important to understand the difference. AM reception will deteriorate when passing under a bridge or when passing under high voltage lines. Although AM is subject to environmental noise, it has the ability to receive at great distance. This is because broadcasting signals follow the curvature of the earth and are reflected back by the upper atmosphere.

TROUBLESHOOTING

Symptom	Solution
Radio will not turn ON or No front panel operation	Try the reset button.
	Check fuse.
	Check 12V+ on accessory wire to radio (RED wire)
	Check Ground.
Radio turns ON, but no sound	Verify Volume, Fader/Balance, Mute controls are set correctly (see owner's manual).
	Try the reset button.
	Verify proper speaker selection.
	Verify proper speaker connections.
	Check for shorts or open circuits on speaker wires. <ul style="list-style-type: none"> • If short on "A" channel, "B & C" channels will continue to function. • If short on "B and/or C" channels, "A" channel will continue to function.
Bluetooth Device will not connect/pair	Make sure no devices are already connected. Disconnect any connected devices.
	On your smart device, turn the Bluetooth off and on and try again.
CD/DVD does not play correctly	Make sure unit has power and no other CD/DVD is currently inside.
	Make sure the disc is a compatible disc.
CD/DVD does not play correctly	Check to make sure disc is inserted correctly.
	Verify disc is free from dirt, scratches, etc.
	Check with factory Cds.
	Check factory original CDs for compatibility warnings (due to various copy-protection, multimedia content, etc.).
No AM or FM reception	Verify you are tuned to a valid station.
	Check your antenna connection on rear of stereo.
	Try a different antenna
DVD plays sound but no video	Make sure the HDMI cable is routed from the HDMI output to the input on the television.
Unit does not respond to Remote Control	Verify that you have a clear line of sight for the IR signal.
	Check the batteries.



DESIGNED TO MOVE [YOU][®]

SPECIFICATIONS

FM Tuner

Frequency Coverage (USA)	87.5 to 107.9 MHz
Frequency Coverage (Europe)	87.5 to 108 MHz
Sensitivity	<4 μ V
Stereo Separation@1 kHz	>25 dB

AM Tuner

Frequency Range (USA)	530-1710 kHz
Frequency Range (Europe)	522-1620 kHz
Sensitivity (S/N=20dB)	<63 μ V

Amplifier

Output Power	6W x 8
Output Impedance	Compatible with 4-8 Ω ohms speakers, 4 ohm load minimum

DVD

Frequency Response	20-20,000 Hz
Channel Separation	50 dB
S/N Ratio	65 dB
Distortion	0.5%

General

Power Supply Requirements	DC 12 Volts, Negative Ground
Operating Voltage	10-16 VDC
Overall Dimensions	265.0mm (W) x 95.0mm (D) x 194.4mm (H)
.....	10.4" (W) x 3.8" (D) x 7.7" (H)
Mounting Dimensions	236.2mm (W) x 155.2mm (D) x 73.6mm (H)
.....	9.3" (W) x 6.11" (D) x 5.12" (H)
Weight	1.7 KG
.....	3.75 lbs

FCC Notice

NOTE: This equipment has been tested and found to comply with the limits for a Class B digital device, pursuant to Part 15 of the FCC Rules. These limits are designed to provide reasonable protection against harmful interference in a residential installation. This equipment generates uses and can radiate radio frequency energy and, if not installed and used in accordance with the instructions, may cause harmful interference to radio communications. However, there is no guarantee that interference will not occur in a particular installation. If this equipment does cause harmful interference to radio or television reception, which can be determined by turning the equipment off and on, the user is encouraged to try to correct the interference by one or more of the following measures:

- Reorient or relocate the receiving antenna.
- Increase the separation between the equipment and receiver.
- Connect the equipment into an outlet on a circuit different from that to which the receiver is connected.
- Consult the dealer or an experienced radio/TV technician for help.

WARNING: Changes or modifications not expressly approved by the party responsible for compliance could void the user's authority to operate the equipment. This equipment complied with FCC radiation exposure limits set forth for an uncontrolled environment. This equipment should be installed and operated with minimum distance 20cm between the radiator & your body.

NOTE: The manufacturer is not responsible for any radio or TV interference caused by unauthorized modifications to this equipment. Such modifications could void the user's authority to operate the equipment.



2602 Marina Drive • Elkhart, IN 46514

www.asaelectronics.com